

F-Theta f=80mm

Drawing No. SH39-1064-56-80-8

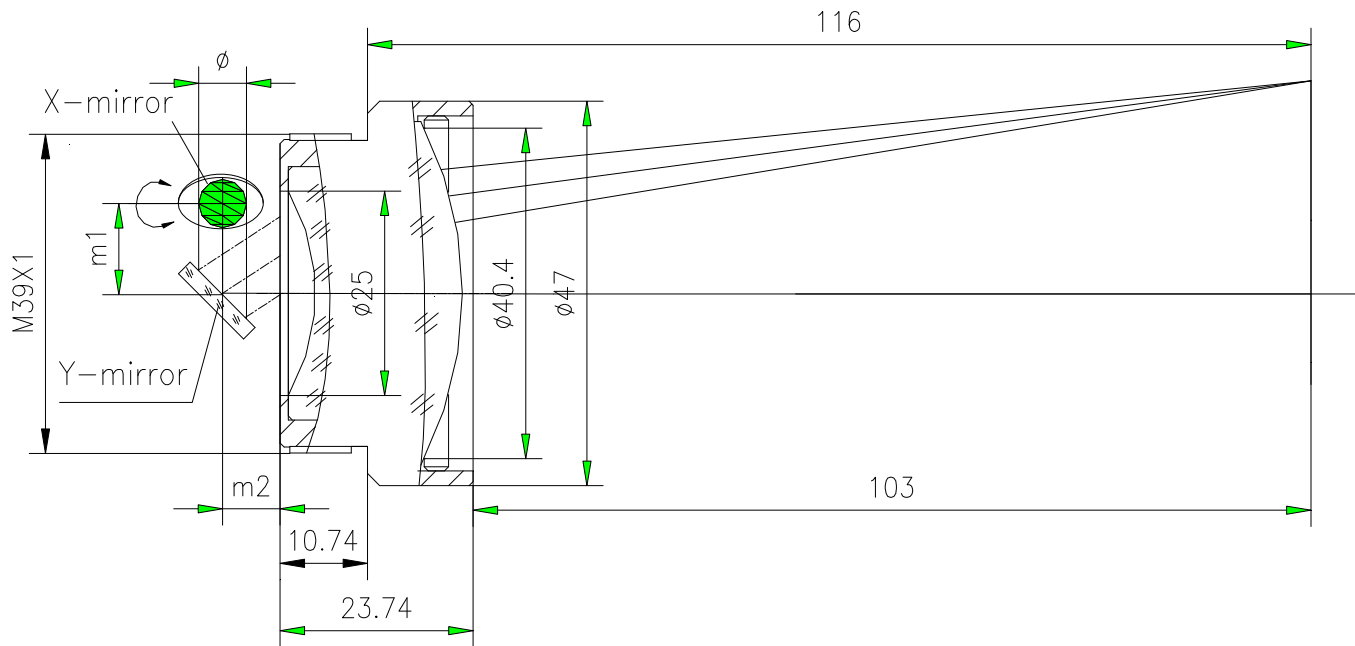

Specification

EFL	80mm
WD	103mm
Wavelength	$\lambda = 1064\text{nm}$
scan angle	$\pm 27^\circ$
max scan field	56mm x 56mm
Entrance beam diameter \varnothing	8mm
Center point diameter ($1/e^2$)	20 μm
Edge point diameter ($1/e^2$)	21 μm
mirror distance m1	10-12
mirror distance m2	7-9
Transmission >	98%
Thread	M39x1
With protective window	no