

F-Theta f=210mm

Drawing No. SH-532-145-210-12

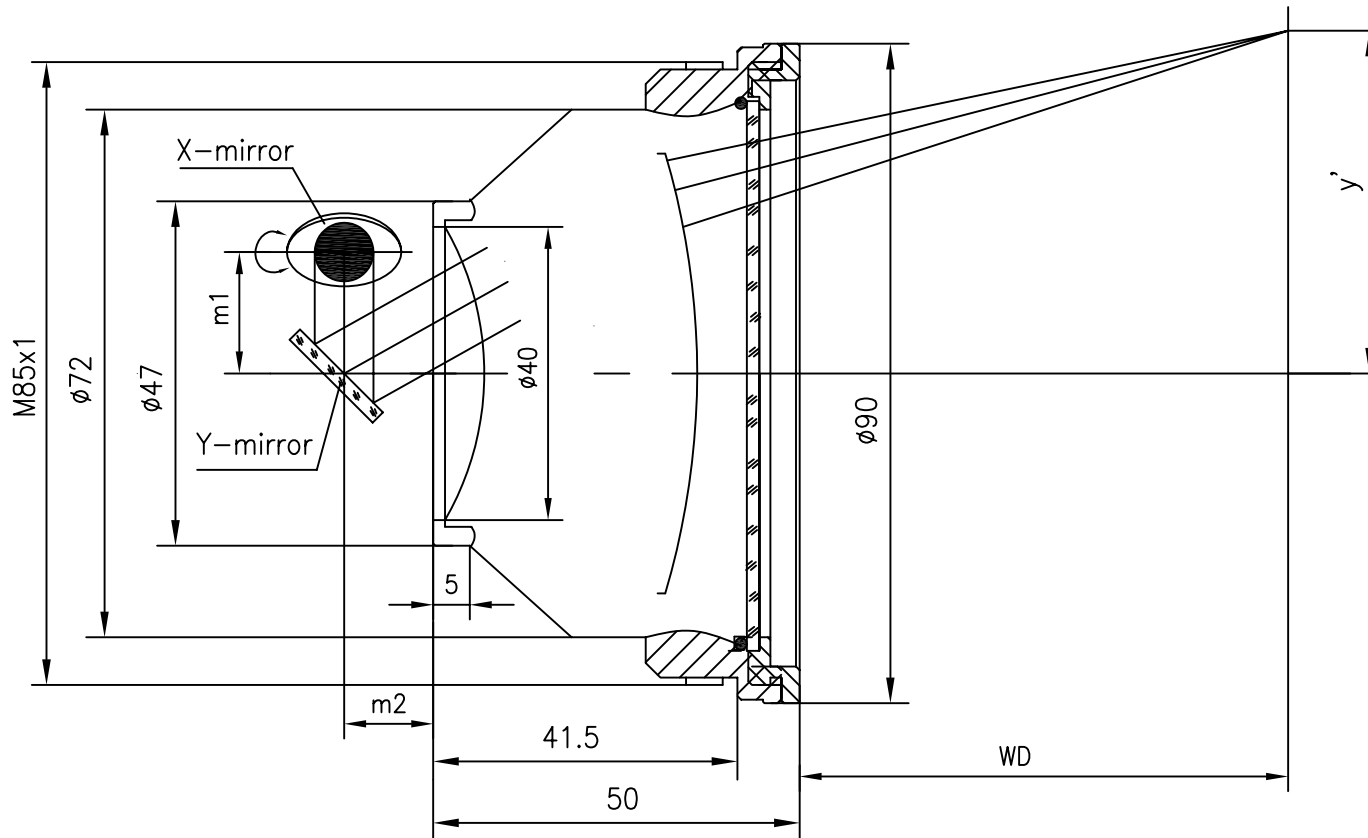

Specification

EFL	210mm
WD	232,5mm
Wavelength	$\lambda = 532\text{nm}$
scan angle	$\pm 28^\circ$
max scan field	145mm x 145mm
Entrance beam diameter \varnothing	12mm
Center point diameter ($1/e^2$)	21 μm
Edge point diameter ($1/e^2$)	23 μm
mirror distance m1	16-20
mirror distance m2	10-12
Transmission >	97%
Thread	M85x1
With protective window	yes