

F-Theta f=254mm

Drawing No. SH-355-175-254-8

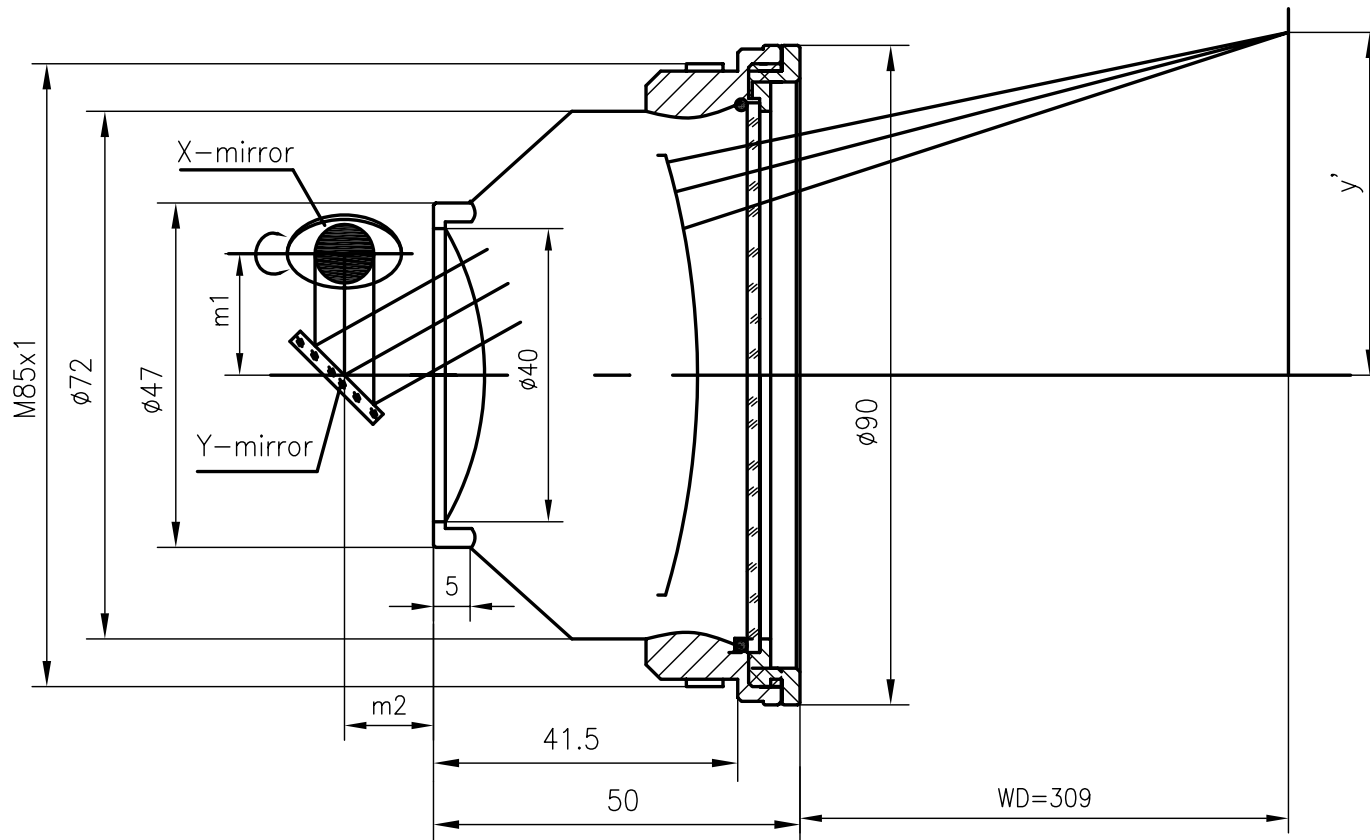

Specification

EFL	254mm
WD	309mm
Wavelength	$\lambda = 355\text{nm}$
scan angle	$\pm 25^\circ$
max scan field	175mm x 175mm
Entrance beam diameter ϕ	8mm
Center point diameter ($1/e^2$)	24 μm
Edge point diameter ($1/e^2$)	25 μm
mirror distance m1	12-20
mirror distance m2	10-16
Transmission >	97%
Thread	M85x1
With protective window	yes