

F-Theta f=100mm

Drawing No. SH-1064-70-100-12

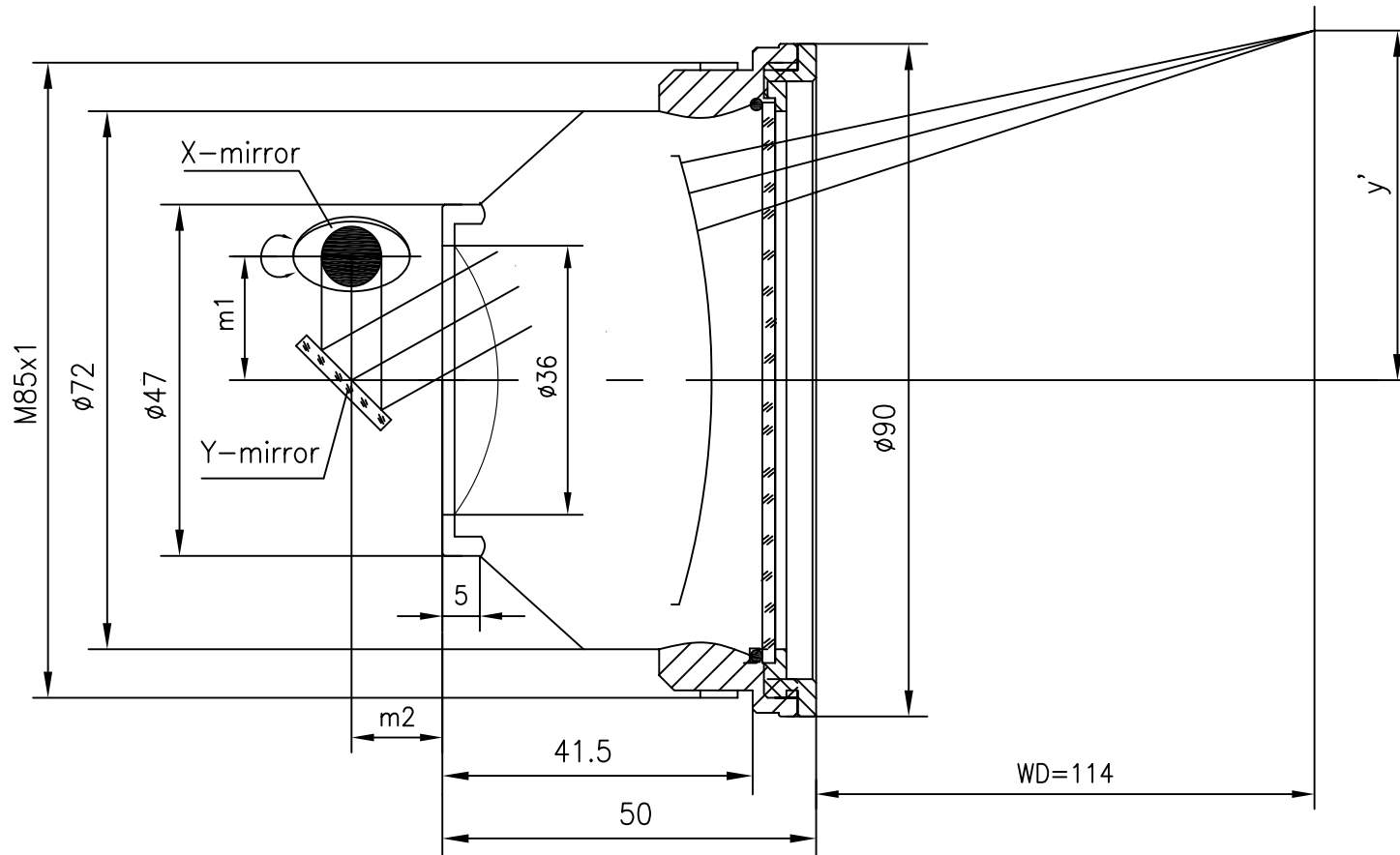

Specification

EFL	100mm
WD	114mm
Wavelength	$\lambda = 1064\text{nm}$
scan angle	$\pm 28^\circ$
max scan field	70mm x 70mm
Entrance beam diameter ϕ	12mm
Center point diameter ($1/e^2$)	16 μm
Edge point diameter ($1/e^2$)	17 μm
mirror distance $m1$	16-20
mirror distance $m2$	10-12
Transmission >	97%
Thread	M85x1
With protective window	yes