

# F-Theta f=63mm

## Drawing No. SH-1064-50-63-12

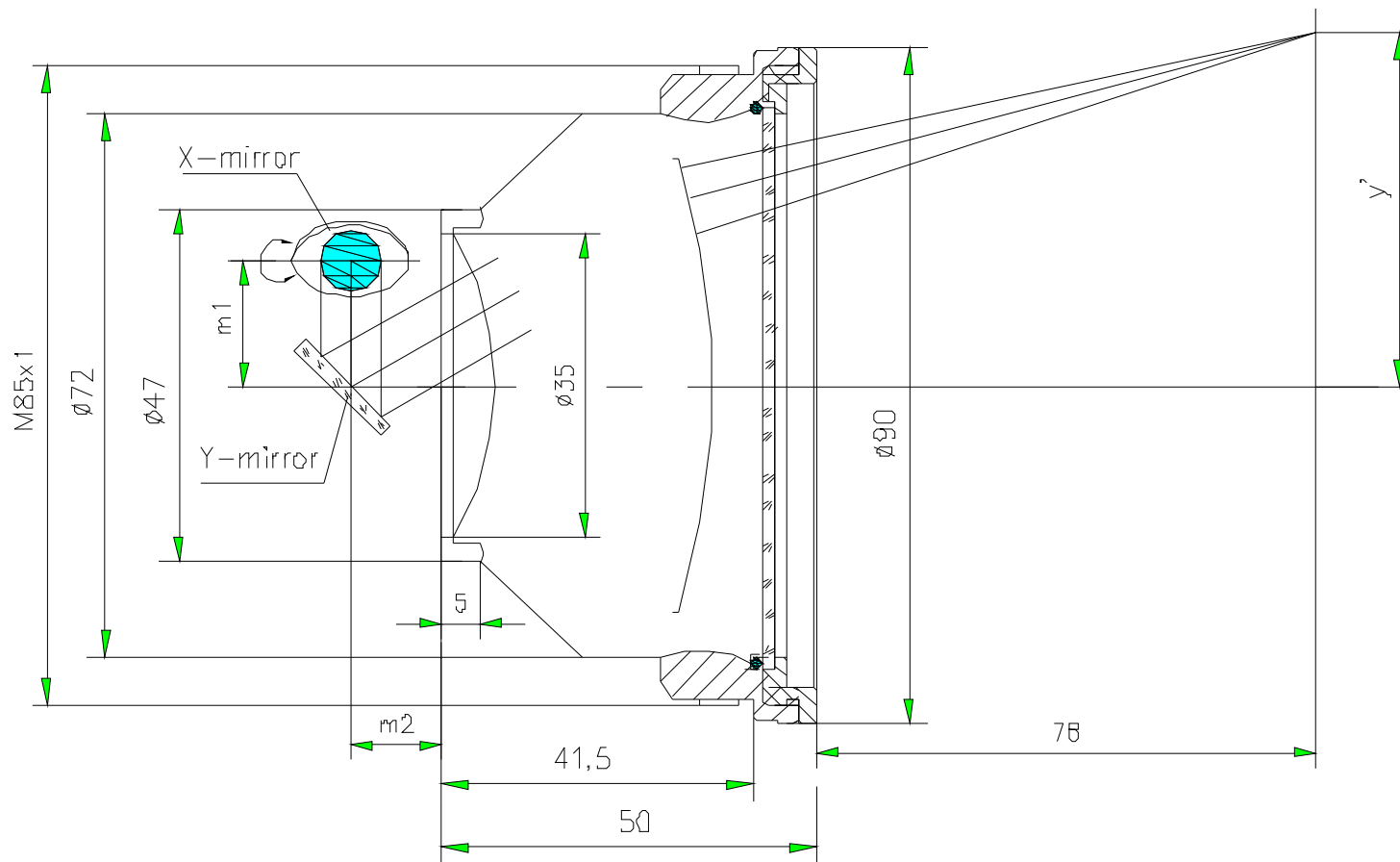

### Specification

EFL	63mm
WD	78mm
Wavelength	$\lambda = 1064\text{nm}$
scan angle	$\pm 25^\circ$
max scan field	50mm x 50mm
Entrance beam diameter $\varnothing$	12mm
Center point diameter ( $1/e^2$ )	10 $\mu\text{m}$
Edge point diameter ( $1/e^2$ )	11 $\mu\text{m}$
mirror distance m1	16-18
mirror distance m2	10-12
Transmission >	97%
Thread	M85x1
With protective window	yes