

F-Theta f=420mm

Drawing No. SH-1064-300-420-20

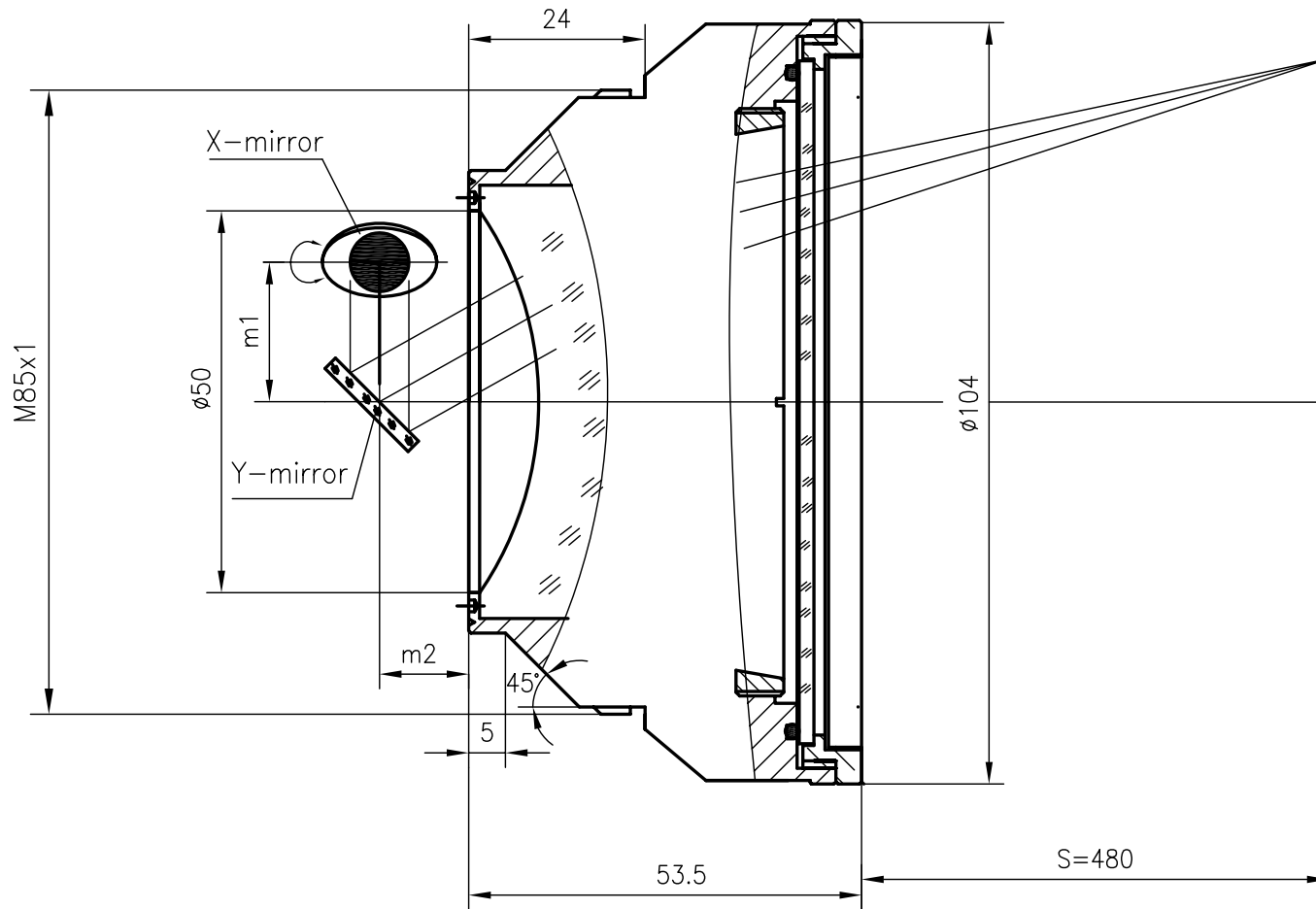

Specification

EFL	420mm
S	480mm
Wavelength	$\lambda = 1064\text{nm}$
scan angle	$\pm 28^\circ$
max scan field	300mm x 300mm
Entrance beam diameter \varnothing	20mm
Center point diameter ($1/e^2$)	55 μm
Edge point diameter ($1/e^2$)	58 μm
mirror distance m1	18
mirror distance m2	24
Transmission >	98%
Thread	M85x1
With protective window	yes