

# F-Theta f=290mm

## Drawing No. SH-1064-200-290-12

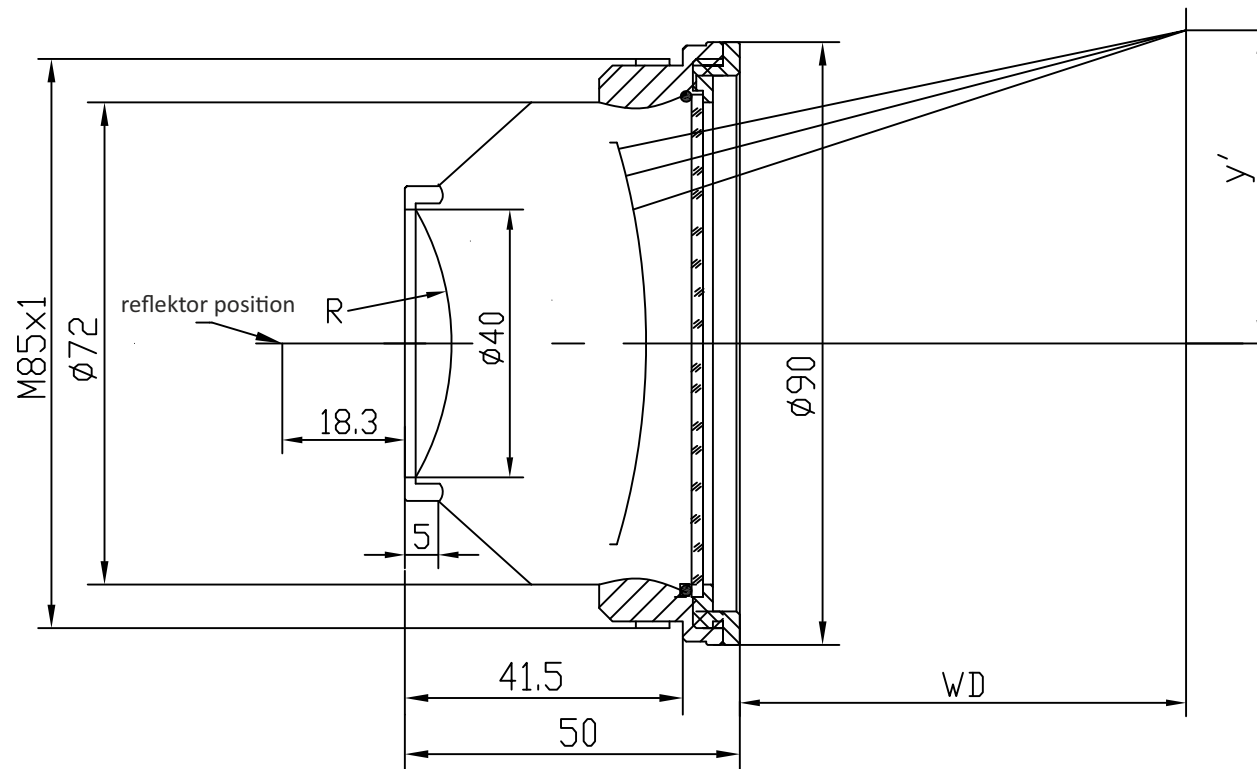

### Specification

EFL	290mm
WD	324mm
Wavelength	$\lambda = 1064\text{nm}$
scan angle	$\pm 28^\circ$
max scan field	200mm x 200mm
Entrance beam diameter $\varnothing$	12mm
Center point diameter ( $1/e^2$ )	35 $\mu\text{m}$
Edge point diameter ( $1/e^2$ )	37 $\mu\text{m}$
mirror distance m1	16-20
mirror distance m2	10-12
Transmission >	97%
Thread	M85x1
With protective window	yes