

F-Theta f=254mm

Drawing No. SH-1064-175-254-12

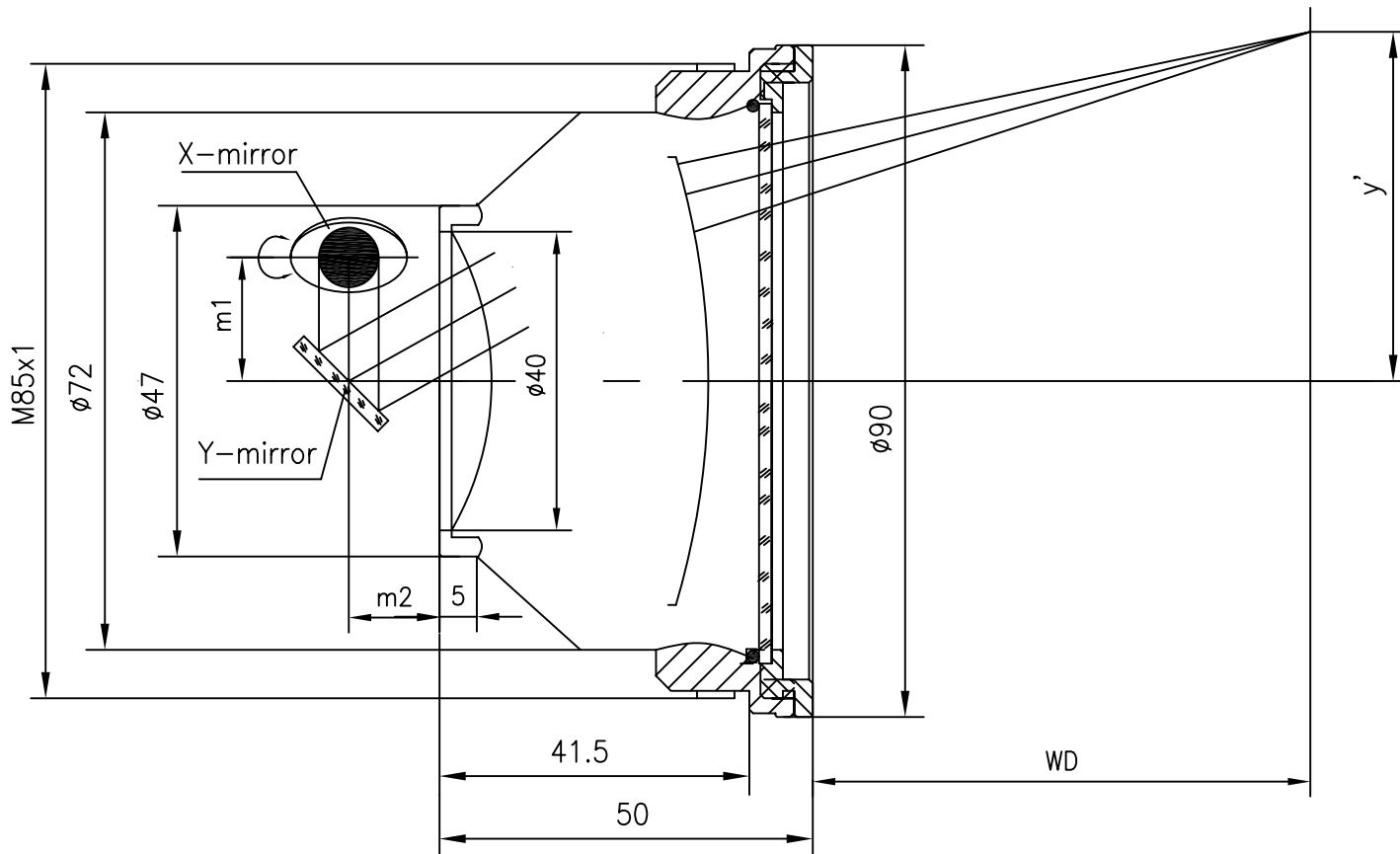

Specification

EFL	254mm
WD	287mm
Wavelength	$\lambda = 1064\text{nm}$
scan angle	$\pm 28^\circ$
max scan field	175mm x 175mm
Entrance beam diameter ϕ	12mm
Center point diameter ($1/e^2$)	41 μm
Edge point diameter ($1/e^2$)	42 μm
mirror distance m1	16-20
mirror distance m2	10-12
Transmission >	97%
Thread	M85x1
With protective window	yes