

F-Theta f=160mm

Drawing No. SH-10,6-48-110-160-14

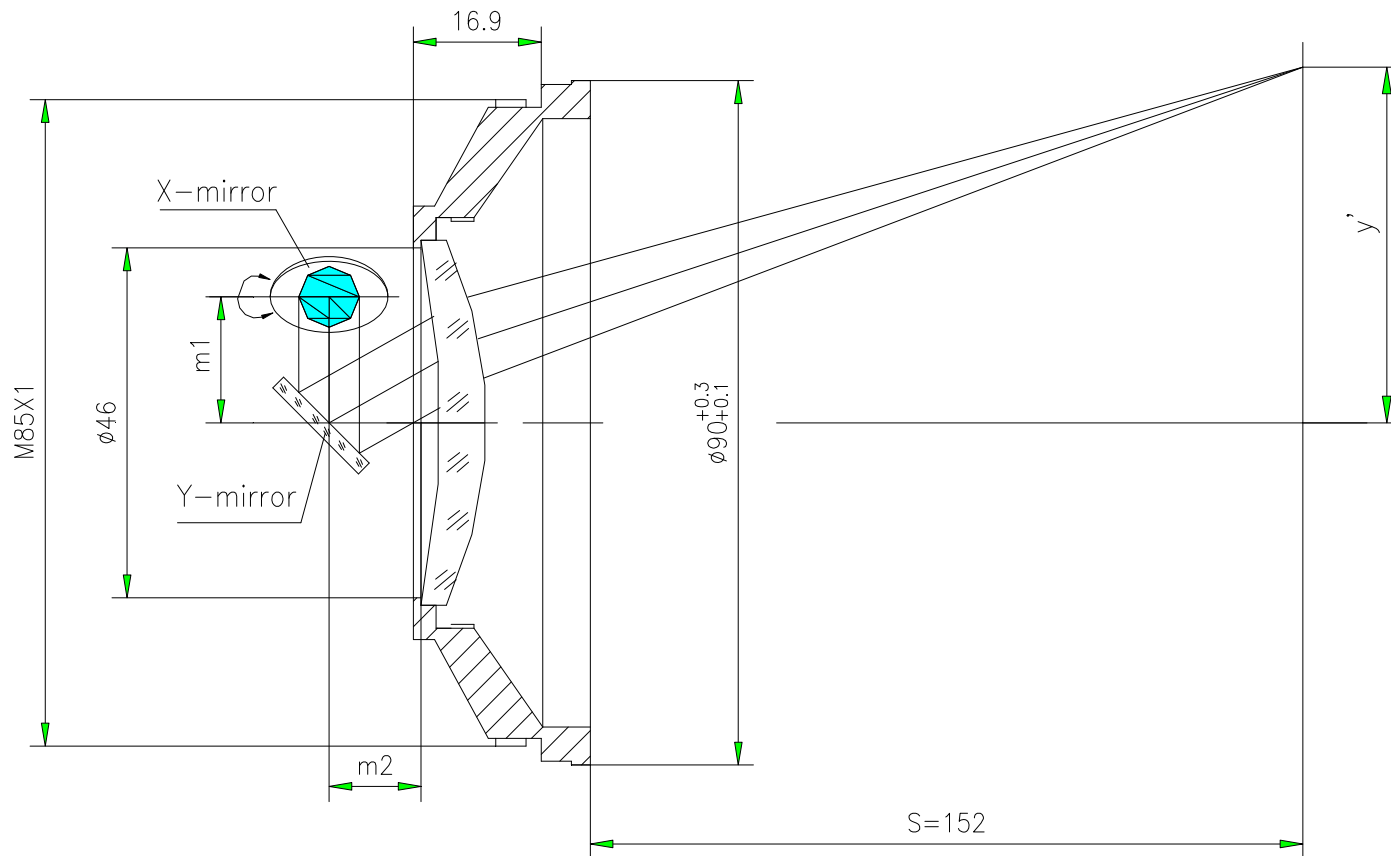

Specification

EFL	160mm
S	152mm
Wavelength	$\lambda = 10,6 \mu\text{m}$
scan angle	$\pm 28^\circ$
max scan field	110mm x 110mm
Entrance beam diameter \varnothing	14mm
Center point diameter ($1/e^2$)	220 μm
Edge point diameter ($1/e^2$)	230 μm
mirror distance m1	16-20
mirror distance m2	10-12
Transmission >	97%
Thread	M85x1